

Data Sheet

HH-181-36×4-xx-PH3030

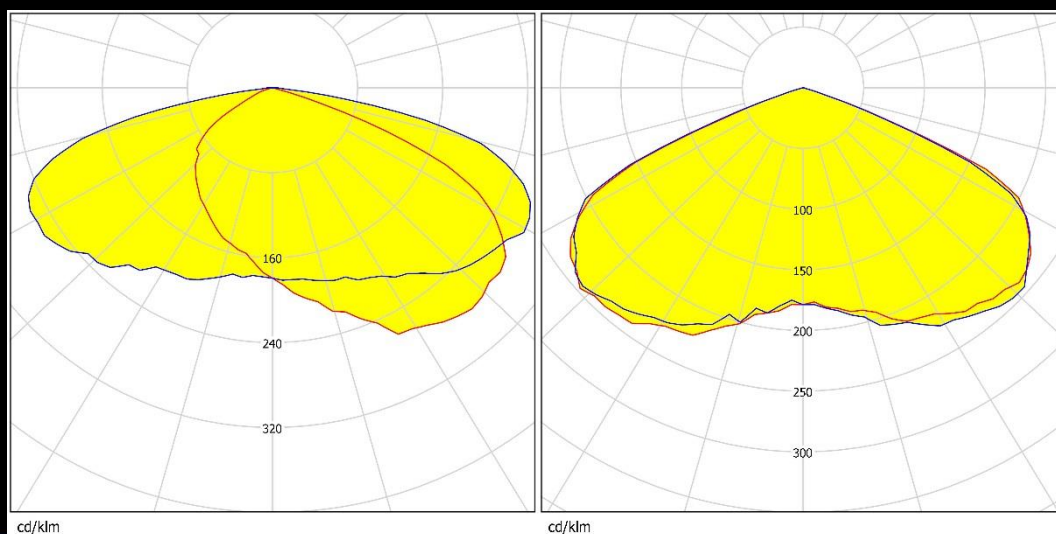
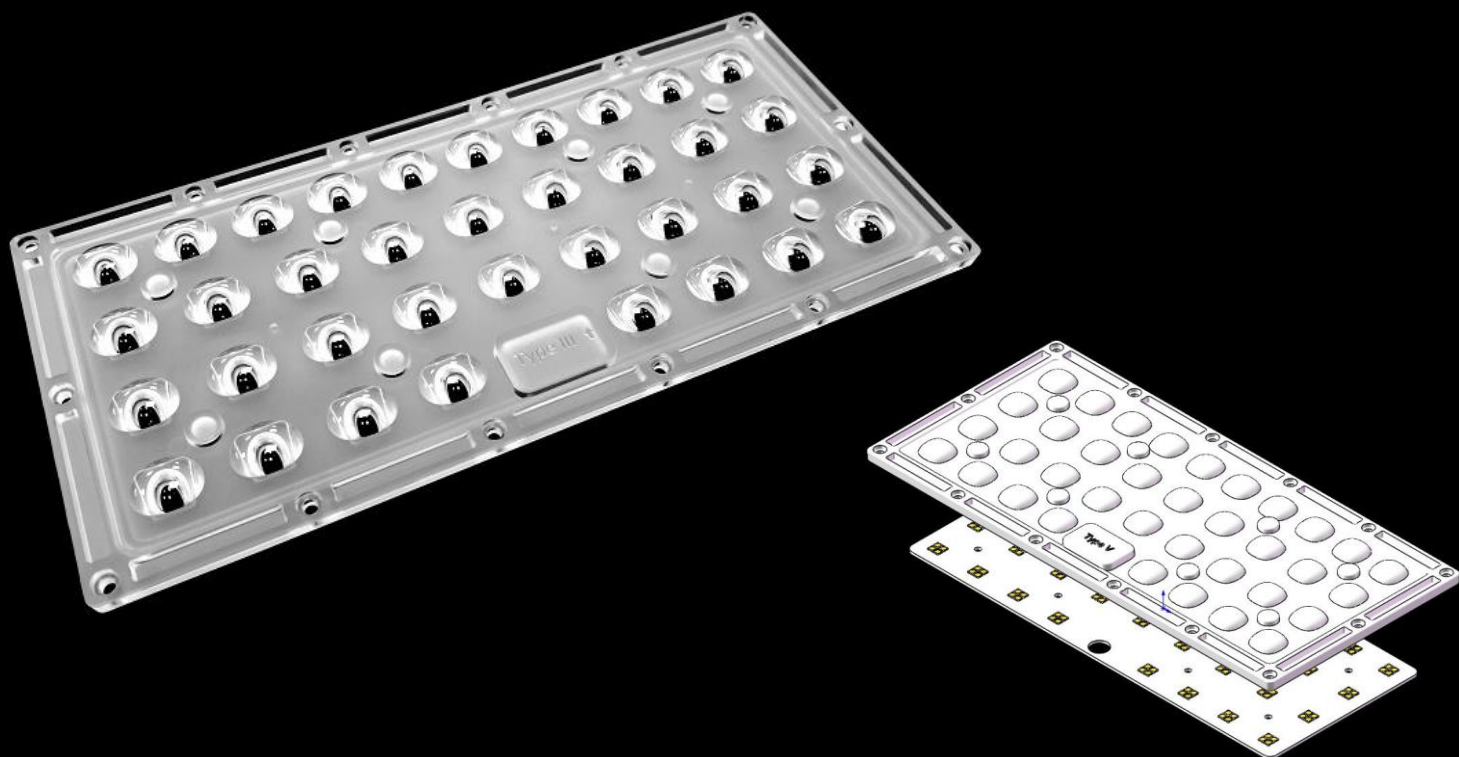

深圳市汉辉光电有限公司
shenzhen hanhui photoelectric co.,Ltd.

地址：深圳市宝安区石岩街道石龙仔社区恒昌荣高科技园3栋3楼
ADD: Area A No.3 Building 3th Floor,Hengchang Rong Industrial
park shiyan,shilong community,Bao'an District,shenzhen,china
TEL:86-755-29232420 FAX:86-755-83723765
<http://www.szhanhui.com> <http://linsen4880.1688.com>



Data Sheet

catalogue

General Information	P.1
Optical Specifications	P.2-3
Mechanical Specifications	P.4
Package Specifications	P.5

*Product Nomenclature

HH-181-36 × 4-xx-PH3030

H1 H2 H3 H4 H5 H6 H7

H1 : The company's initials in Pinyin (Han Hui)

H2 : Mold number

H3 : Lens quantity

H4 : The number of lamp beads inside each optical surface

H5 : Lens angle/type (ex : 60、90、T2M、T3M)

H6 : LED type (ex : CREE-CR、SAMSUNG-SS、PHILIPS-PH.....)

H7 : LED size (ex:2835、3030、3535、.....)



HH-181-36×4-xx-PH3030

General Information

v1.0_20190108

◆ Features & Typical Applications

- Available with 2 beam angles
- High efficiency
- optimized Uniformity
- Lens without Holder
- Roadway Lighting

◆ Material Information

Lens Material: PC 1225Z

Operating Temperature range $-40^{\circ}\text{C} \sim +110^{\circ}\text{C}$ (upper limit $+120^{\circ}\text{C}$).

Storage Temperature range $-40^{\circ}\text{C} \sim +110^{\circ}\text{C}$ (upper limit $+120^{\circ}\text{C}$).

*Average transmittance in visible spectrum $400\text{nm} \sim 700\text{nm} > 90\%$.

◆ Usage and Maintenance

1. If necessary, clean lenses with mild soap, water and soft cloth.
2. Never use any commercial cleaning solvents on lenses, like alcohol.
3. Please handle or install lenses with wearing gloves, skin oils may damage lens or its optical characteristic.



HH-181-36×4-xx-PH3030

Optical Specifications

v1.0_20190108

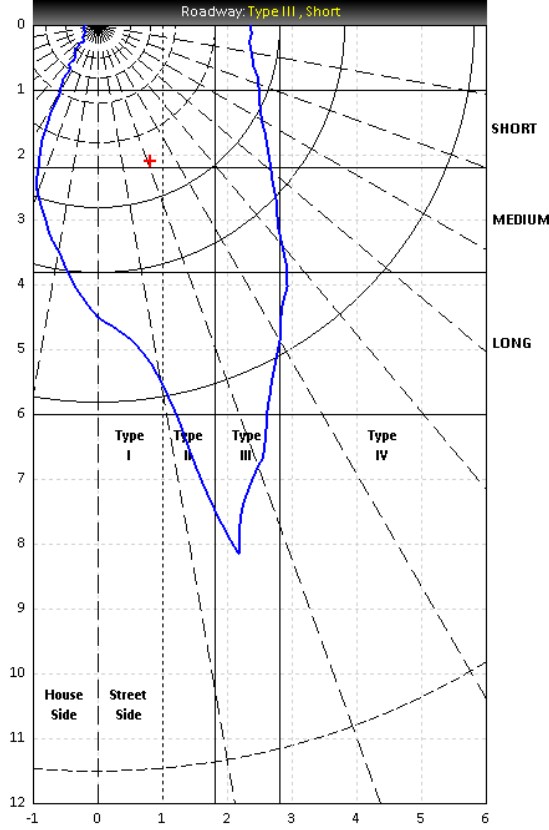
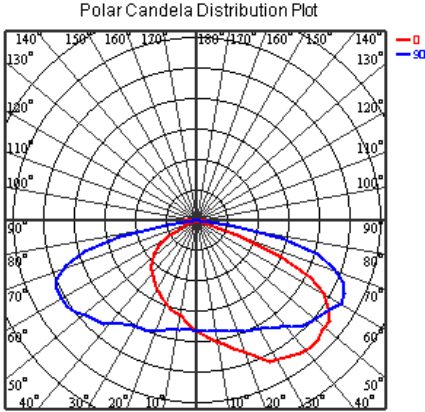
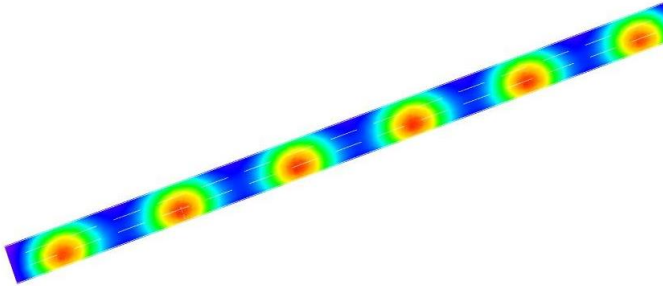
Part Number	FWHM	Candela Distribution Type	IES File
HH-181-36×4-T3S-PH3030	80×150	Type III Short	Download
			
			
DIALux Simulation Result (three lanes, R3W3、ME4a)			
		Recommend configuration condition	
		Luminous Flux	20000lm
<p>Note: Lav-Average Luminance U₀-Brightness Uniformity U_L-Brightness longitudinal Uniformity TI-Threshold increment SR-Surround ratio</p>		Lamp Collocation	Unilateral
		Height	10m
		Distance	35m
		Roadwidth	11.25m
		Elevation	0°
		Overhang	1m
		Result	
		Lav	1.13
		U ₀	0.44
		U _L	0.79
		TI(%)	11
		SR	0.65



HH-181-36×4-xx-PH3030

Optical Specifications

v1.0_20190108

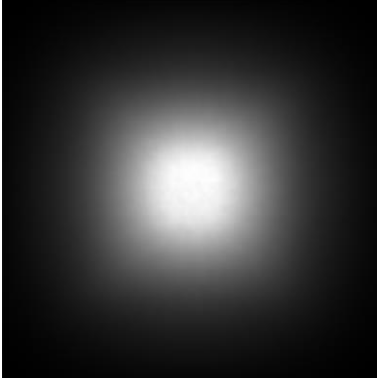
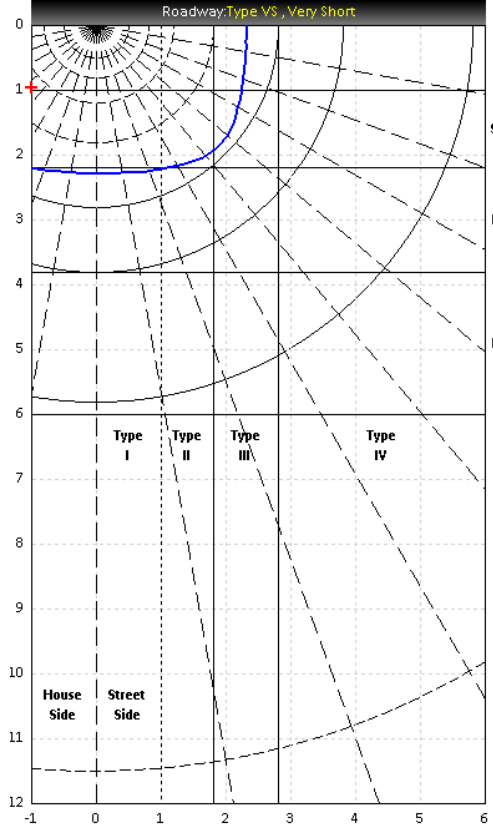
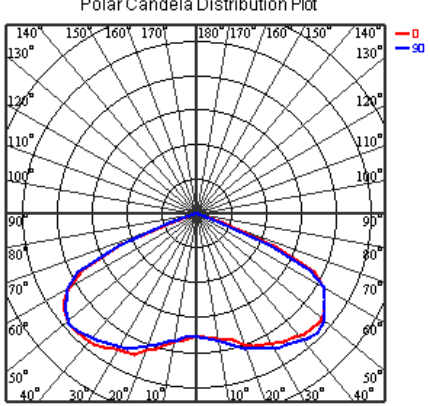
Part Number	FWHM	Candela Distribution Type	IES File
HH-181-36×4-T5VS-PH3030	130	Type VS Very Short	Download
			
			



HH-181-36×4-xx-PH3030

Mechanical Specification

v1.0_20190108

Note: (1) All dimensions are in mm.
(2) All measurements are $\pm 0.15\text{mm}$ unless otherwise indicated.

1. Fixing method

Glue Screw Tape Fixing-ring Frame

2. Lens dimension

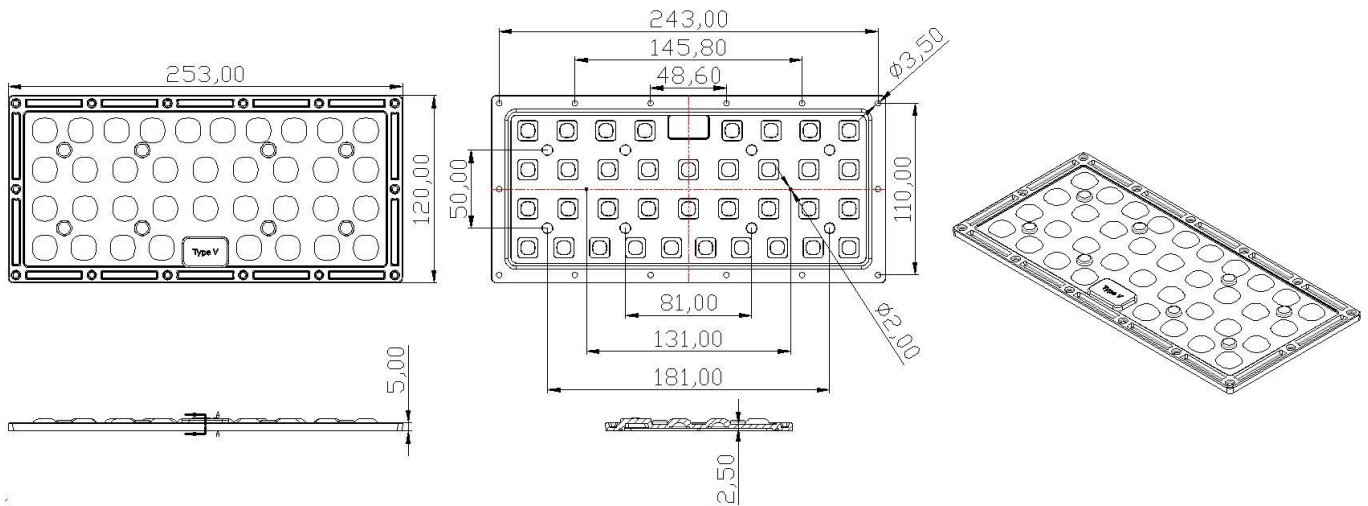

3. Assembly instruction

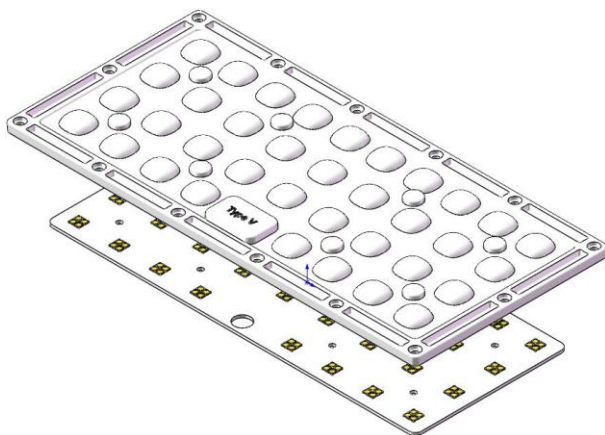

4. View assembly lens with MCPCB

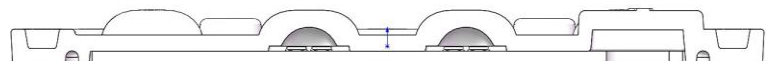

HH-181-36×4-xx-PH3030

Package Specifications

v1.0_20190108

Item	Quantity	Total	Size(L*W*H)	G.W
plastic box	74 PCS/tier	74 PCS	27*27*26cm	
outer box	2 plastic box/outer box	148 PCS	57*28.5*28.5cm	

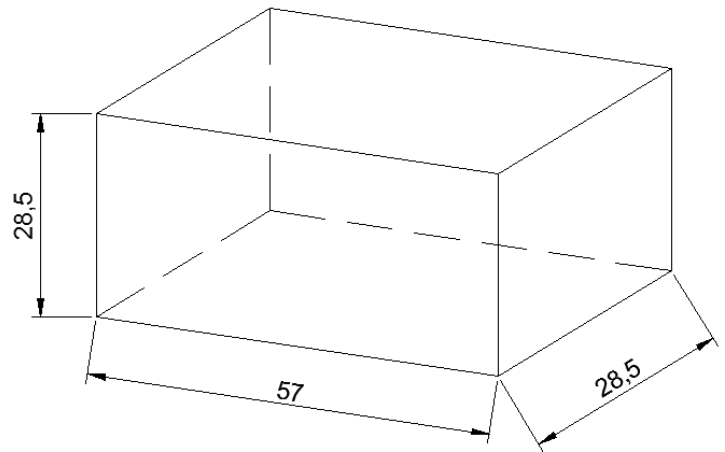
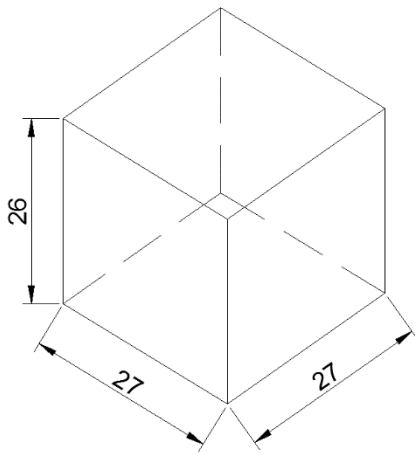

Note:

