

# Data Sheet

HH-182-105×1-xx-OS3737

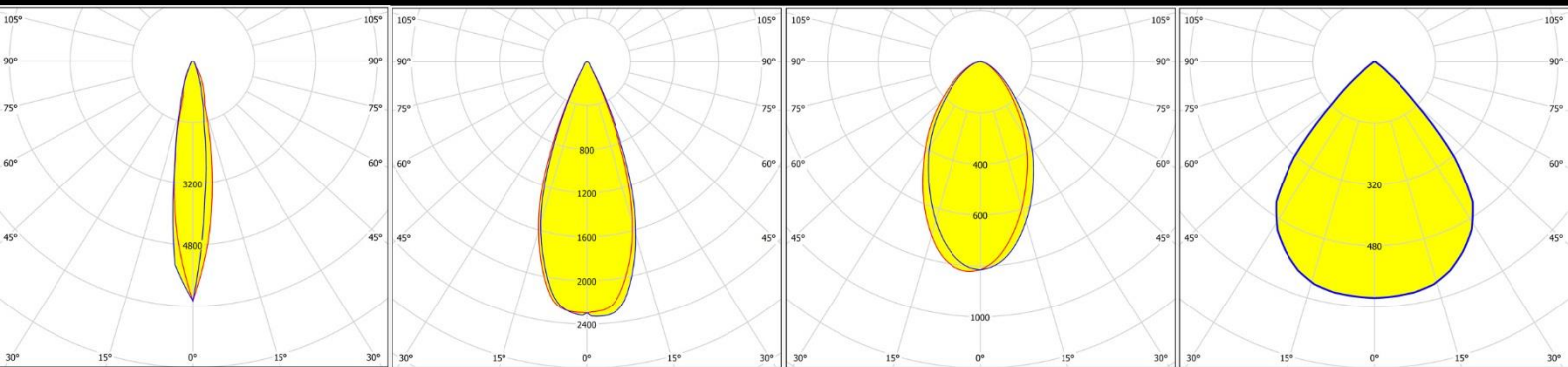
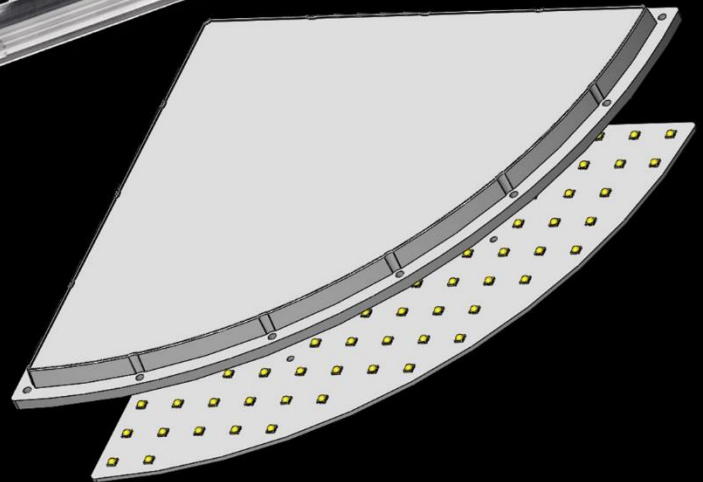

**深圳市汉辉光电有限公司**  
shenzhen hanhui photoelectric co.,Ltd.

地址：深圳市宝安区石岩街道石龙仔社区恒昌荣高科技科技园3栋3楼  
ADD: Area A No.3 Building 3th Floor,Hengchang Rong Industrial  
park shiyan,shilong community,Bao'an District,shenzhen,china  
TEL:86-755-29232420 FAX:86-755-83723765  
<http://www.szhanhui.com> <http://linsen4880.1688.com>



# Data Sheet

## catalogue

General Information	.....	P.1
Optical Specifications	.....	P.2
Mechanical Specifications	.....	P.3
Package Specifications	.....	P.4

### \*Product Nomenclature

HH-182-105 × 1-xx-OS3737

H1          H2          H3          H4 H5          H6          H7

H1: The company's initials in Pinyin (Han Hui)

H2: Mold number

H3: Lens quantity

H4: The number of lamp beads inside each optical surface

H5: Lens angle/type (ex: 60、90、T2M、T3M)

H6: LED type (ex: CREE-CR、SAMSUNG-SS、OSRAM-OS.....)

H7: LED size (ex:2835、3030、3535、.....)



# HH-182-105×1-xx-OS3737

## General Information

v1.0\_20181117

### ◆ Features & Typical Applications

- Available with 3 beam angles
- High efficiency
- optimized Uniformity
- Lens without Holder
- Court Light

### ◆ Material Information

Lens Material: PC 1225Z

Operating Temperature range  $-40^{\circ}\text{C} \sim +110^{\circ}\text{C}$  (upper limit  $+120^{\circ}\text{C}$ ).

Storage Temperature range  $-40^{\circ}\text{C} \sim +110^{\circ}\text{C}$  (upper limit  $+120^{\circ}\text{C}$ ).

\*Average transmittance in visible spectrum  $400\text{nm} \sim 700\text{nm} > 90\%$ .

### ◆ Usage and Maintenance

1. If necessary, clean lenses with mild soap, water and soft cloth.
2. Never use any commercial cleaning solvents on lenses, like alcohol.
3. Please handle or install lenses with wearing gloves, skin oils may damage lens or its optical characteristic.





# HH-182-105×1-xx-OS3737

## Optical Specifications

v1.0\_20181117

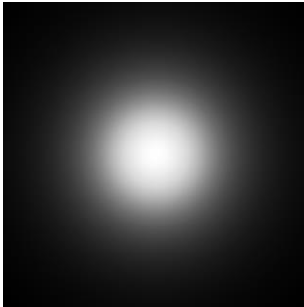
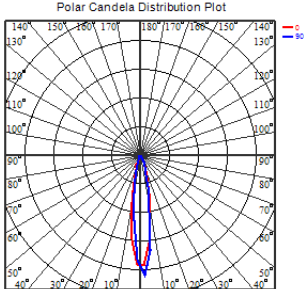
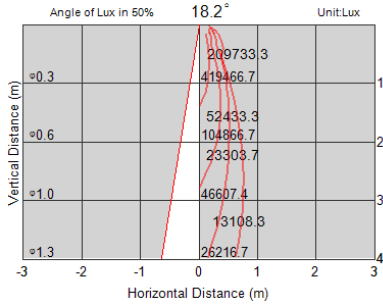
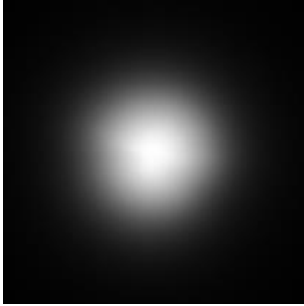
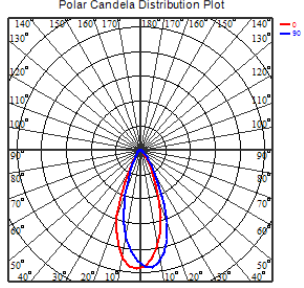
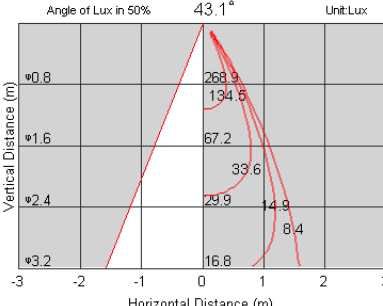
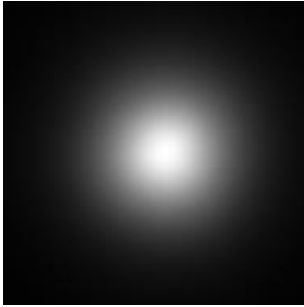
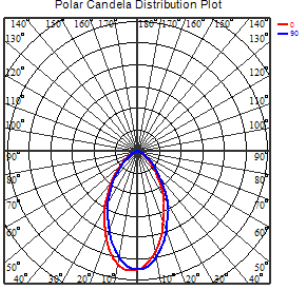
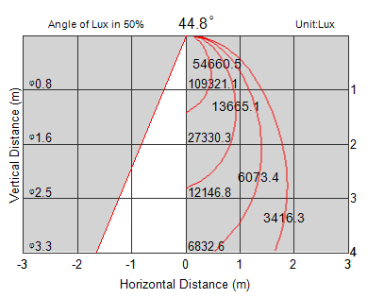
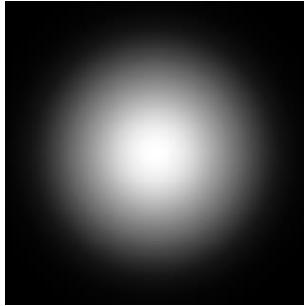
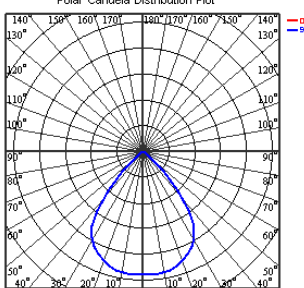
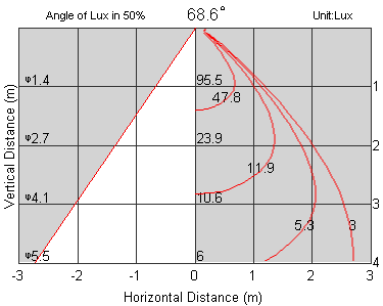
Part Number	FWHM	Field Angle*	cd/lm	IES File
HH-182-105×1-15-OS3737	15.7°	37.4°	6.5	<a href="#">Download</a>
				
HH-182-105×1-40-OS3737	40°	57.5°	1.6	<a href="#">Download</a>
				
HH-182-105×1-60-OS3737	59.1°	115.5°	0.8	<a href="#">Download</a>
				
HH-182-105×1-80-OS3737	80.3°	101.3°	0.69	<a href="#">Download</a>
				
Beam Pattern	Candela Distribution	Illuminance Distribution		



# HH-182-105×1-xx-OS3737

## Mechanical Specification

v1.0\_20181117

### 1. Fixing method

Note: (1) All dimensions are in mm.  
(2) All measurements are  $\pm 0.15\text{mm}$  unless otherwise indicated.

- Glue     
  Screw     
  Tape     
  Fixing-ring     
  Frame

### 2. Lens dimension

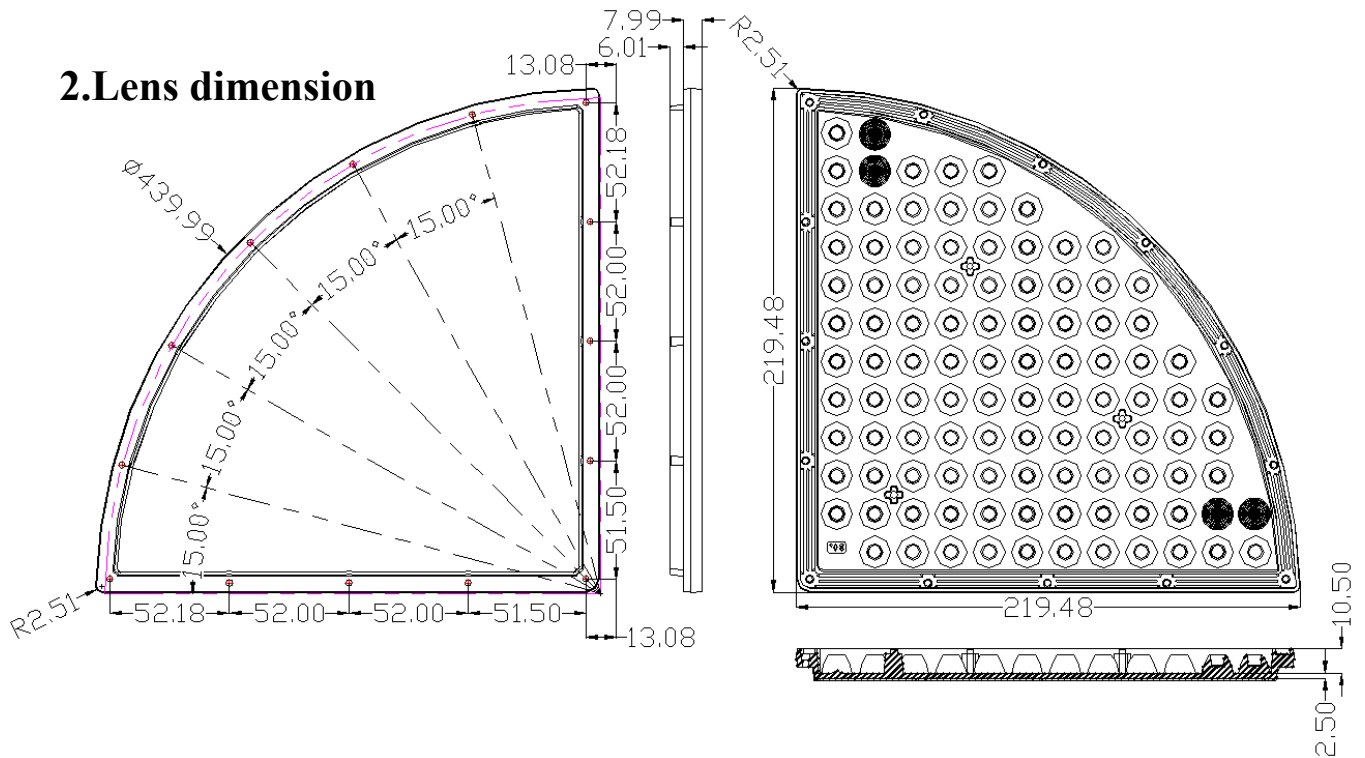

### 3. Assembly instruction

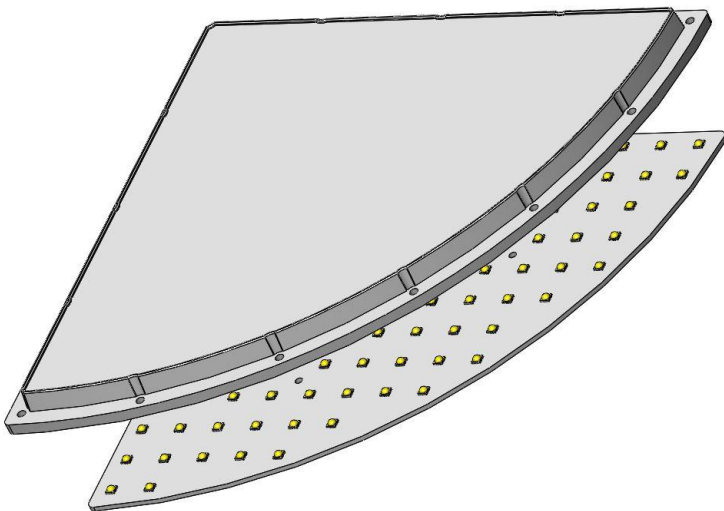

### 4. View assembly lens with MCPCB

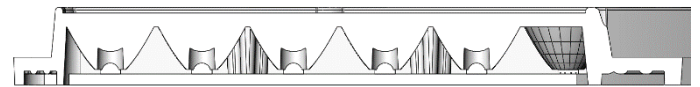

# HH-182-105×1-xx-OS3737

## Package Specifications

v1.0\_20181117

Item	Quantity	Total	Size(L*W*H)	G.W
plastic box	-	-	-	-
outer box	1 outer box	32 PCS	38.5*28.5*23cm	

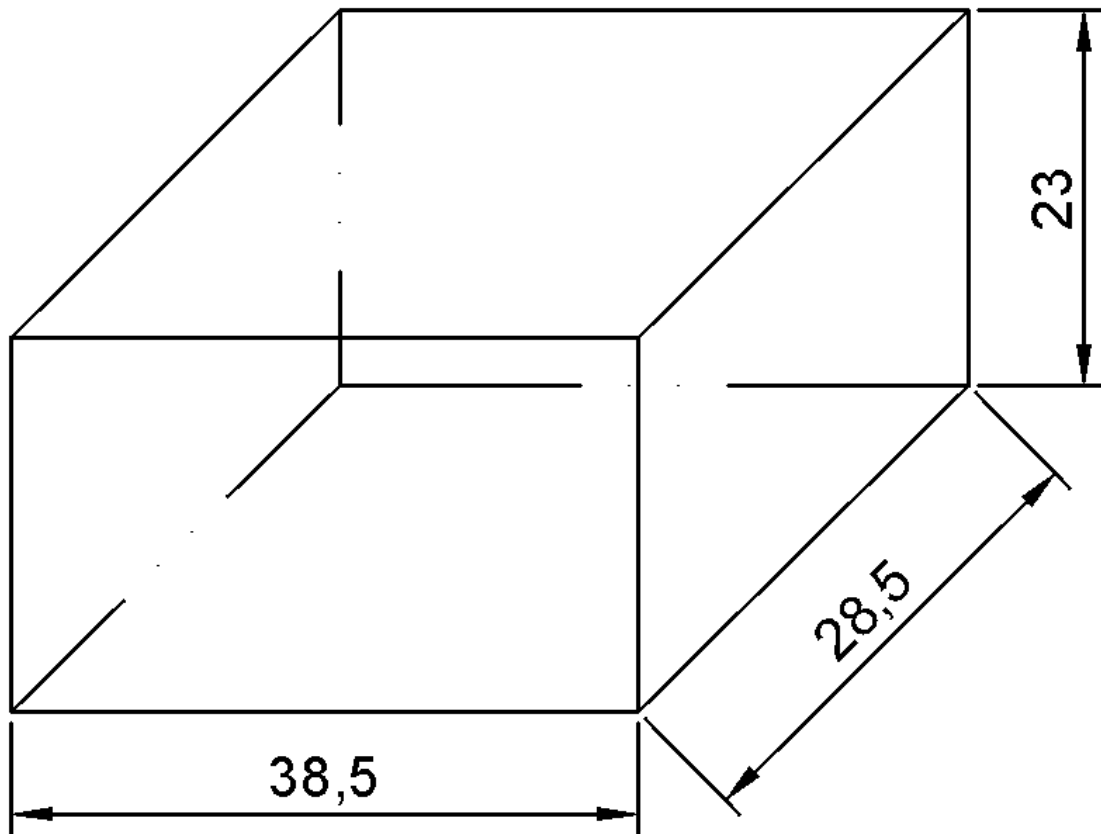

Note:

