

Data Sheet

HH-404-296×1-xx-PH3030

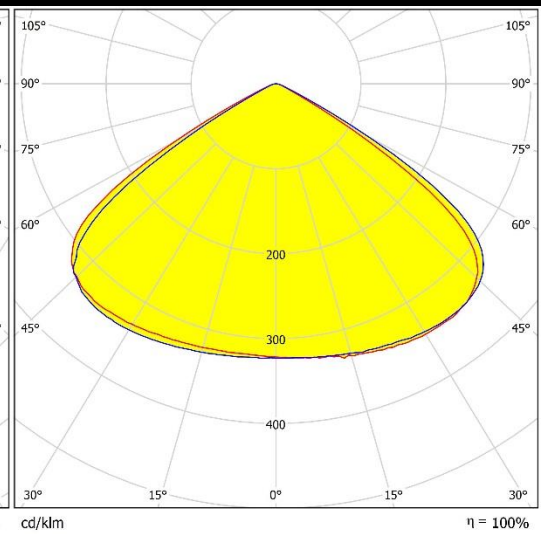
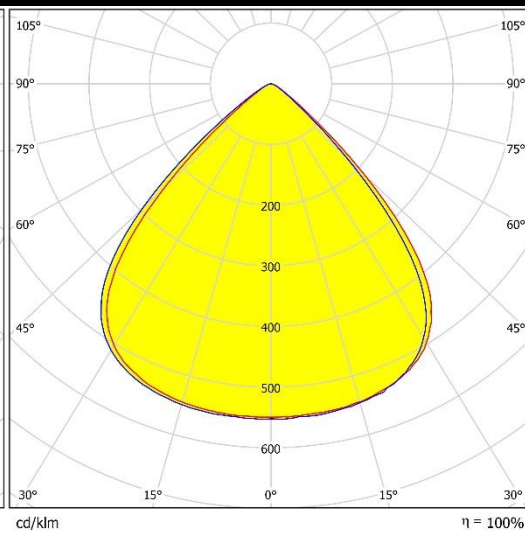
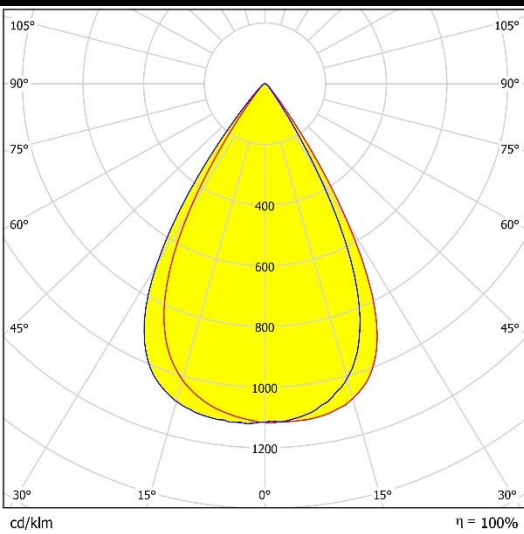
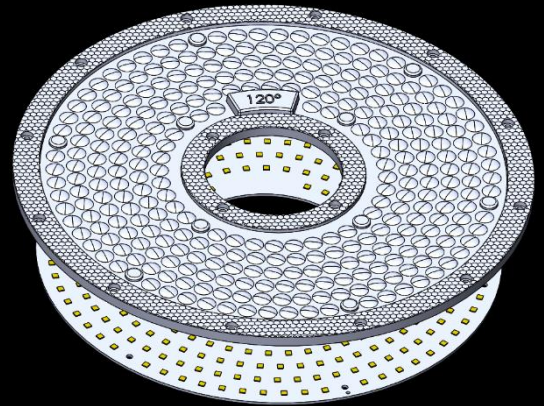

深圳市汉辉光电有限公司
shenzhen hanhui photoelectric co.,Ltd.

地址：深圳市宝安区石岩街道石龙仔社区恒昌荣高科技科技园3栋3楼
ADD: Area A No.3 Building 3th Floor,Hengchang Rong Industrial
park shiyan,shilong community,Bao'an District,shenzhen,china
TEL:86-755-29232420 FAX:86-755-83723765
<http://www.szhanhui.com> <http://linsen4880.1688.com>



Data Sheet

catalogue

General Information	P.1
Optical Specifications	P.2
Mechanical Specifications	P.3
Package Specifications	P.4

*Product Nomenclature

HH-404-296 × 1-xx-PH3030

H1 H2 H3 H4 H5 H6 H7

H1: The company's initials in Pinyin (Han Hui)

H2: Mold number

H3: Lens quantity

H4: The number of lamp beads inside each optical surface

H5: Lens angle/type (ex: 60、90、T2M、T3M)

H6: LED type (ex: CREE-CR、SAMSUNG-SS、PHILIPS-PH.....)

H7: LED size (ex:2835、3030、3535、.....)



◆ Features & Typical Applications

- Available with 3 beam angles
- High efficiency
- optimized Uniformity
- Lens without Holder
- High Bay Light

◆ Material Information

Lens Material: PC 1225Z

Operating Temperature range $-40^{\circ}\text{C} \sim +110^{\circ}\text{C}$ (upper limit $+120^{\circ}\text{C}$).

Storage Temperature range $-40^{\circ}\text{C} \sim +110^{\circ}\text{C}$ (upper limit $+120^{\circ}\text{C}$).

*Average transmittance in visible spectrum $400\text{nm} \sim 700\text{nm} > 90\%$.

◆ Usage and Maintenance

1. If necessary, clean lenses with mild soap, water and soft cloth.
2. Never use any commercial cleaning solvents on lenses, like alcohol.
3. Please handle or install lenses with wearing gloves, skin oils may damage lens or its optical characteristic.



HH-404-296×1-xx-PH3030

Optical Specifications

v1.0_20210119

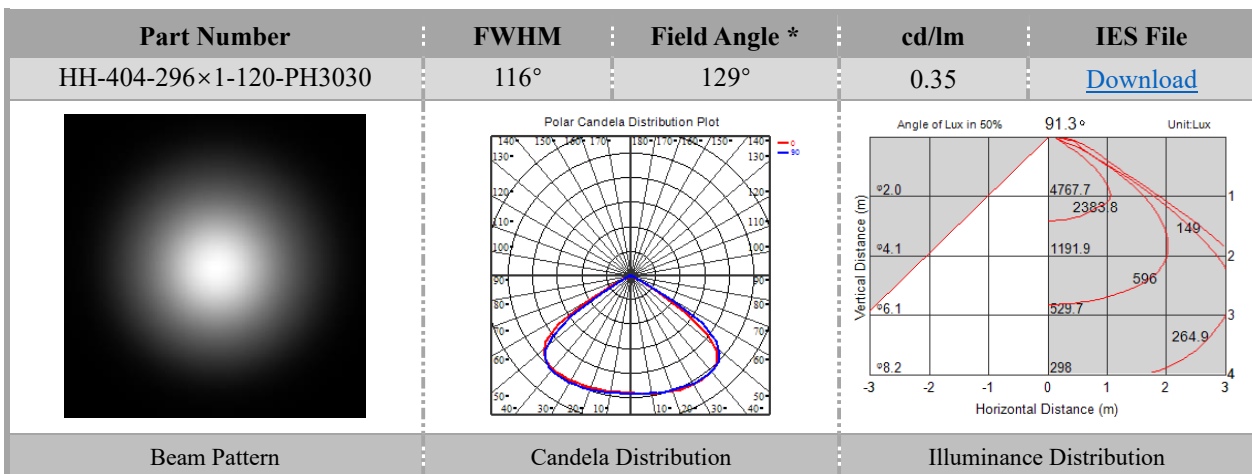
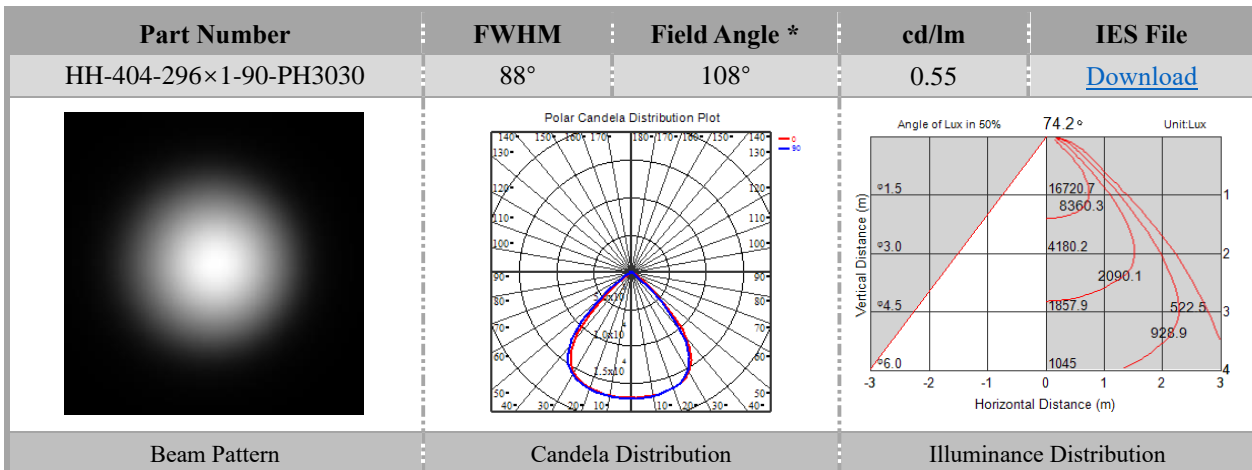
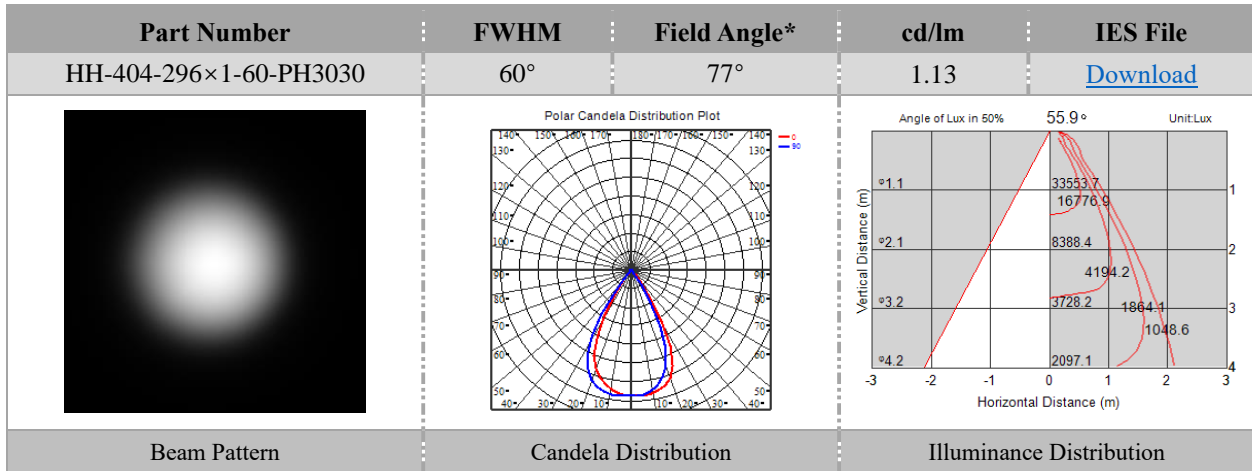

HH-404-296×1-xx-PH3030

Mechanical Specification

v1.0_20210119

Note: (1) All dimensions are in mm.
(2) All measurements are $\pm 0.15\text{mm}$ unless otherwise indicated.

1. Fixing method

- Glue
 Screw
 Tape
 Fixing-ring
 Frame

2. Lens dimension

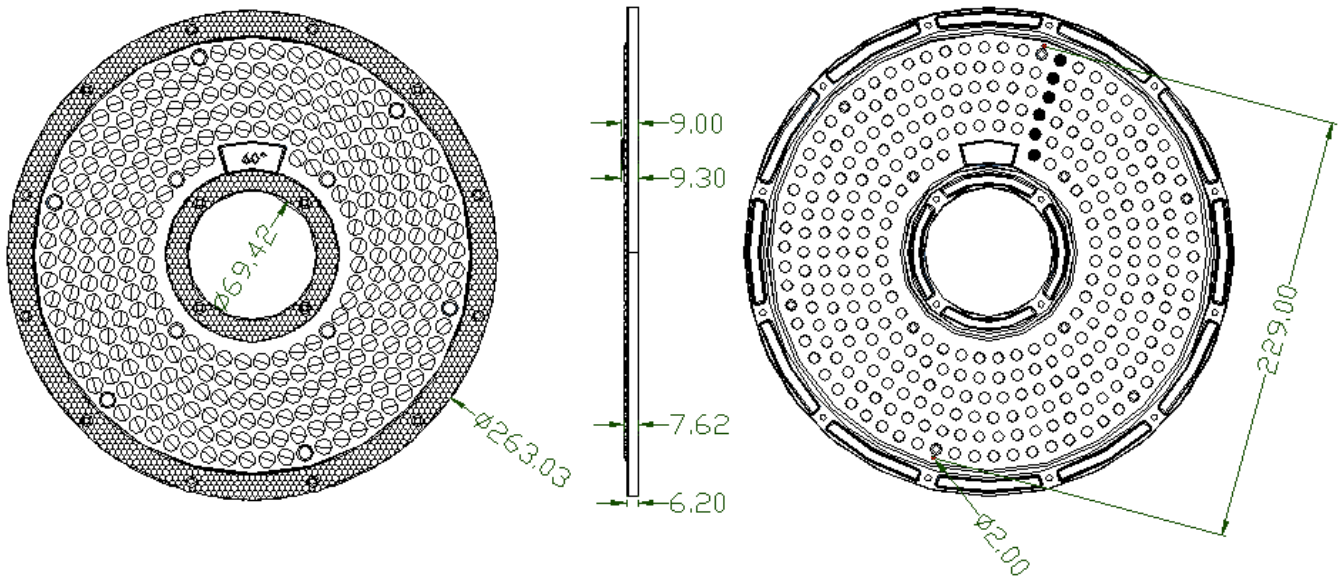

3. Assembly instruction



4. View assembly lens with MCPCB



HH-404-296×1-xx-PH3030

Package Specifications

v1.0_20210119

Item	Quantity	Total	Size(L*W*H)	G.W
plastic box				
outer box				



Note:

