

# 产品数据表

## HH-308-5-xx-PH3030

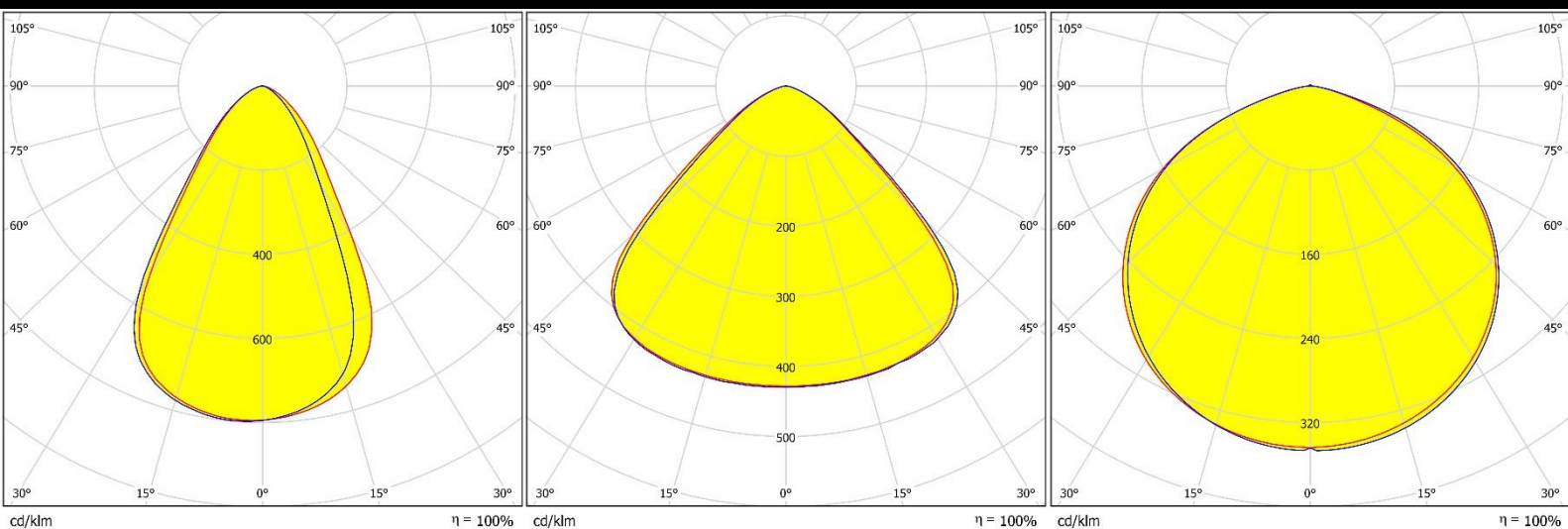
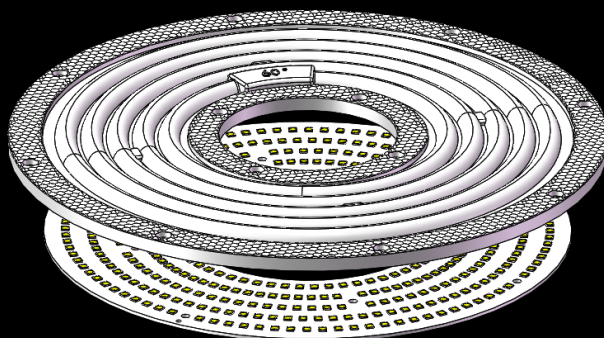
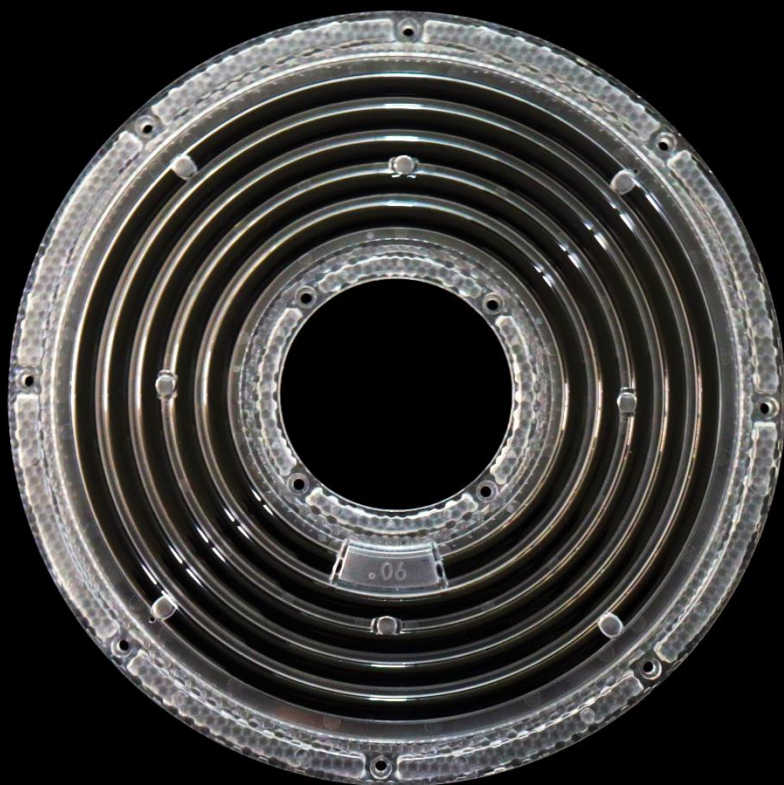

**深圳市汉辉光电有限公司**  
shenzhen hanhui photoelectric co.,Ltd.

地址：深圳市宝安区石岩街道石龙仔社区恒昌荣高科技园3栋3楼  
ADD: Area A No.3 Building 3th Floor,Hengchang Rong Industrial  
park shiyan,shilong community,Bao'an District,shenzhen,china  
TEL:86-755-29232420 FAX:86-755-83723765  
<http://www.szhanhui.com> <http://linsen4880.1688.com>



基本信息	.....	P.1
光学参数	.....	P.2
结构参数	.....	P.3
包装规格	.....	P.4

### \*产品编号说明

HH-308-5-xx-PH3030

H1      H2      H3      H4      H5      H6

**H1:** 公司拼音首字母 (Han Hui)

**H2:** 所属模具模号

**H3:** 光学面数量

**H4:** 透镜角度/类型 (如: 60、90、T2M、T3M)

**H5:** 光源厂家 (如: 科锐 CR、三星 SS、飞利浦 PH.....)

**H6:** 光源尺寸 (如:2835、3030、3535、.....)



## 特征&典型应用

- 3 种不同配光角度
- 效率高
- 均匀度优良
- 透镜无支架
- 工况灯

## 材质信息

透镜材料：PC 1225Z

工作温度范围：-40℃~+110℃（上限值+120℃）

存储温度范围：-40℃~+110℃（上限值+120℃）

\*400nm~700nm 可见光平均透过率>90%

## 使用注意事项

1. 如有必要，用软性肥皂、水和软布清洗透镜。
2. 禁止用工业溶剂清洗透镜，例如酒精。
3. 拿透镜时请带手套，因为皮肤油会影响透镜光学特性。



# HH-308-5-xx-PH3030

## 光学参数

v1.0\_20210119

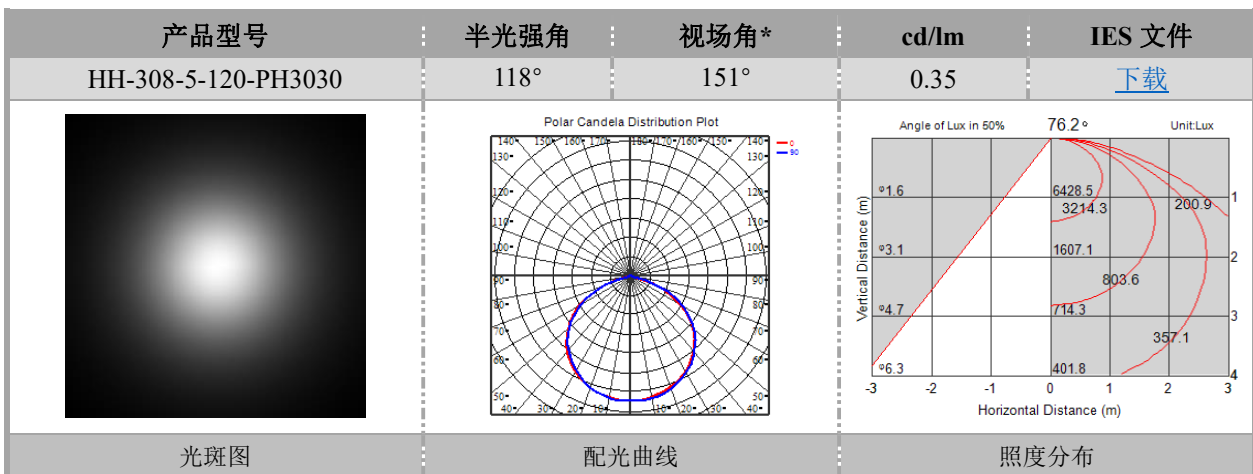
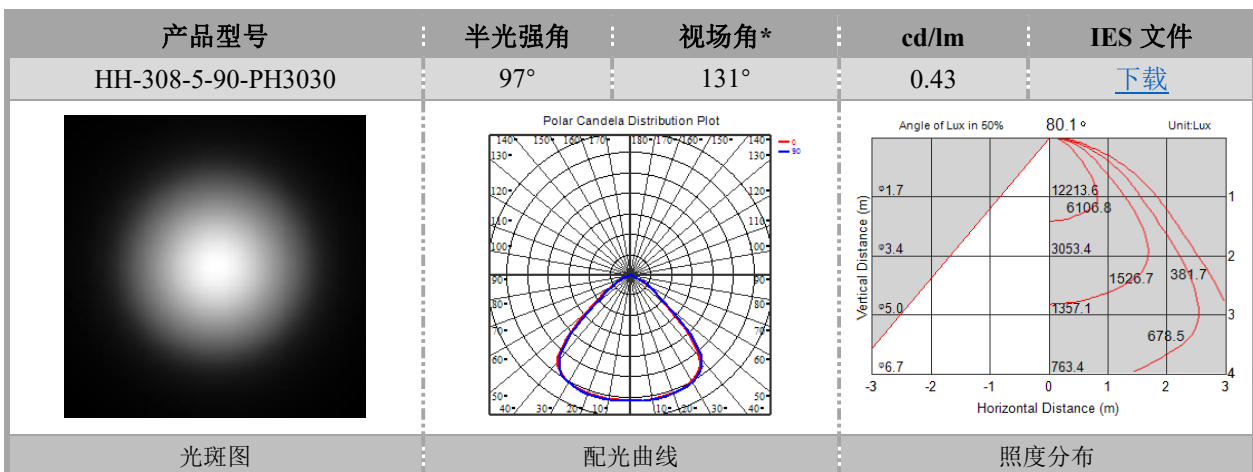
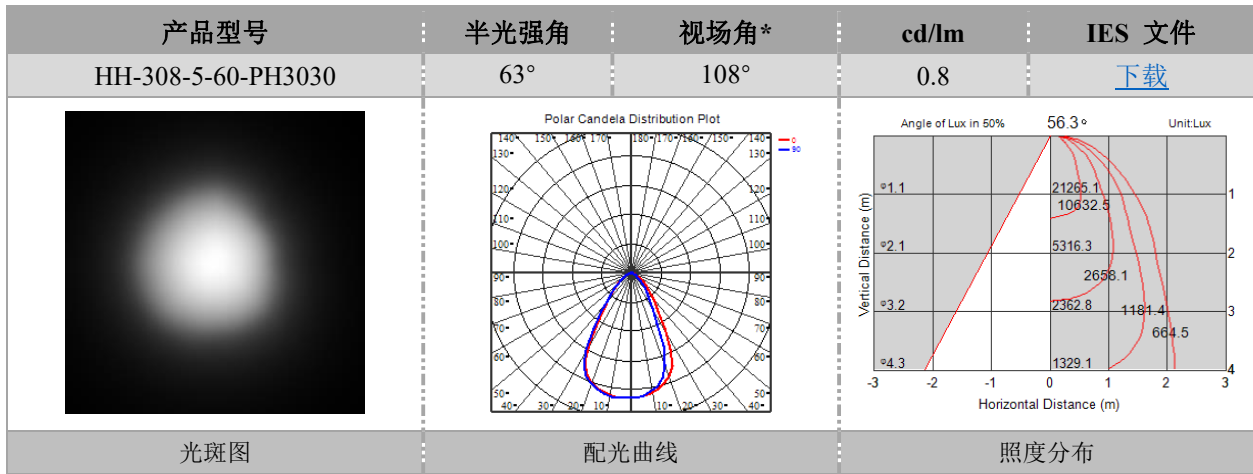

# HH-308-5-xx-PH3030

## 结构参数

v1.0\_20210119

注：(1) 所有计量单位均为 mm。  
(2) 若无特殊说明，所有公差均为  $\pm 0.15$

### 1. 安装固定方式

胶水       螺丝       胶带       固定圈       支架

### 2. 透镜尺寸

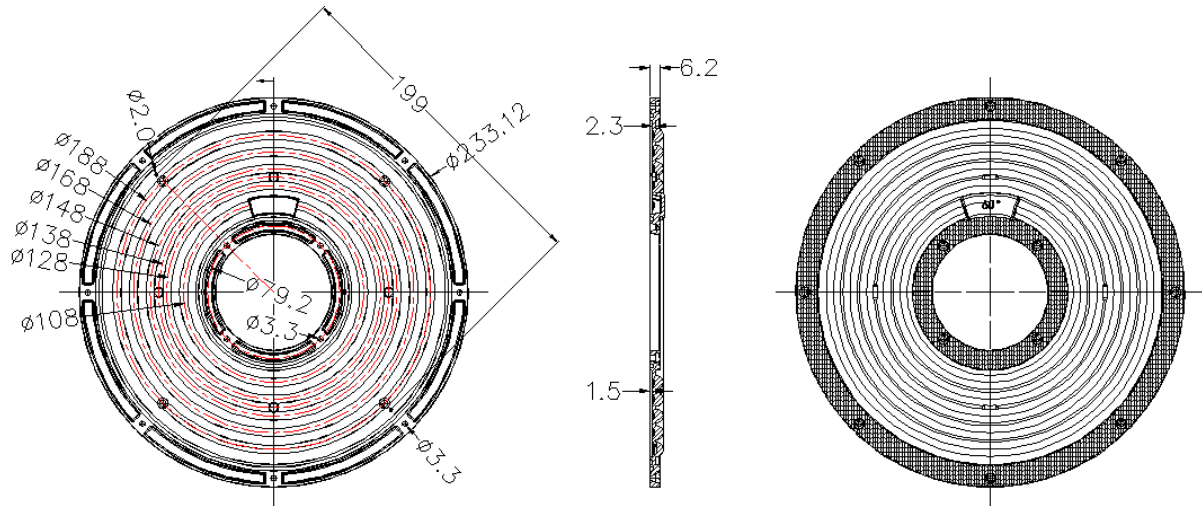

### 3. 装配指示

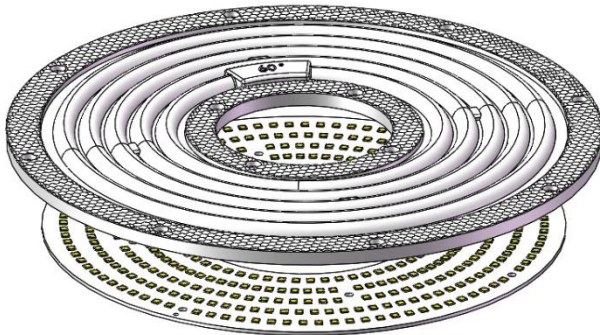

### 4. 透镜装配视图



# HH-308-5-xx-PH3030

## 包装规格

v1.0\_20210119

项目	数量	全部	尺寸(L*W*H)	毛重
内盒				
外箱				



Note:

