

产品数据表

HH-383-6-xx-PH3030

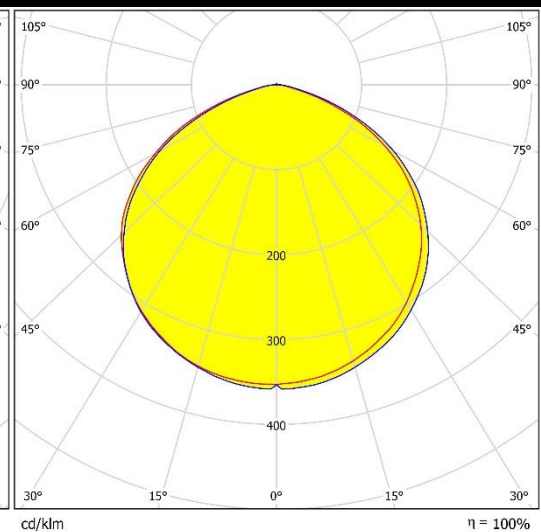
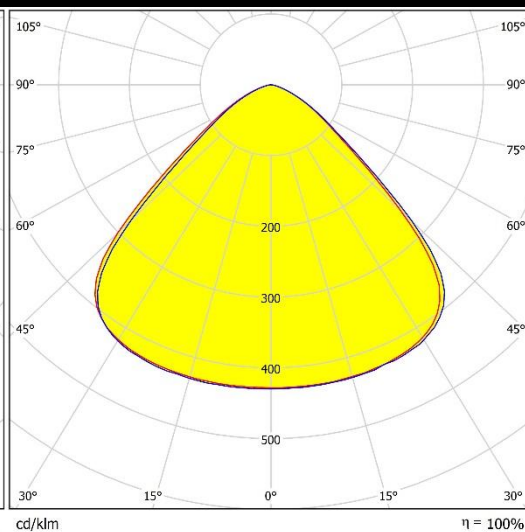
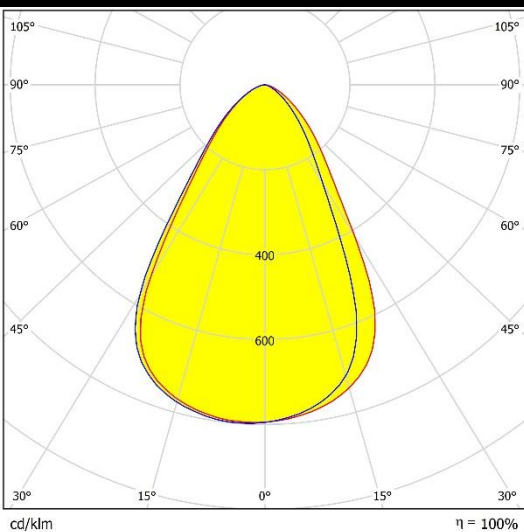
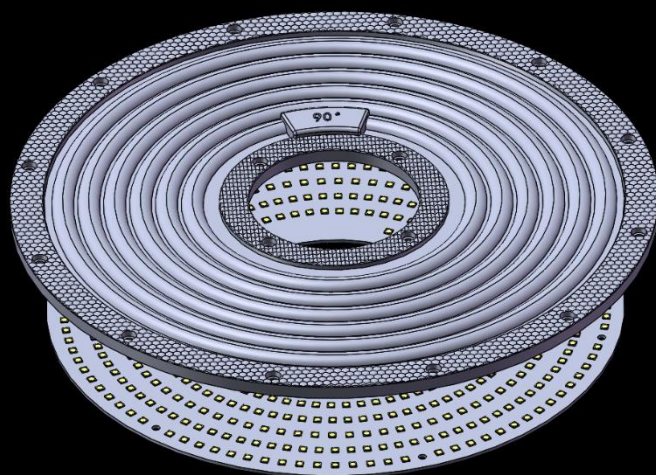
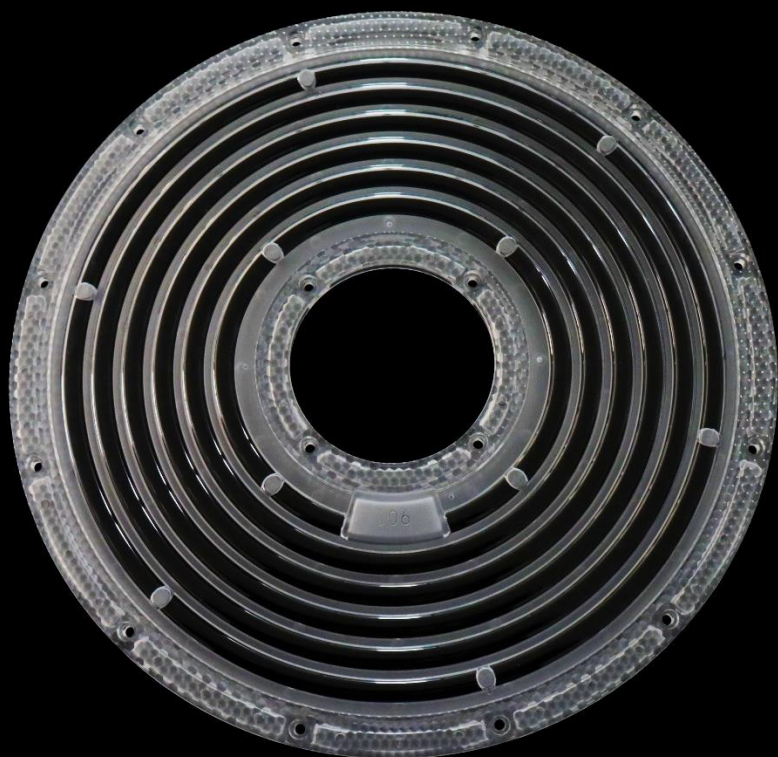

深圳市汉辉光电有限公司
shenzhen hanhui photoelectric co.,Ltd.

地址：深圳市宝安区石岩街道石龙仔社区恒昌荣高科技园3栋3楼
ADD: Area A No.3 Building 3th Floor,Hengchang Rong Industrial
park shiyan,shilong community,Bao'an District,shenzhen,china
TEL:86-755-29232420 FAX:86-755-83723765
http://www.szhanhui.com http://linsen4880.1688.com



基本信息	P.1
光学参数	P.2
结构参数	P.3
包装规格	P.4

*产品编号说明

HH-383-6-XX-PH3030

H1 H2 H3 H4 H5 H6

- H1:** 公司拼音首字母 (Han Hui)
- H2:** 所属模具模号
- H3:** 光学面数量
- H4:** 透镜角度/类型 (如: 60、90、T2M、T3M)
- H5:** 光源厂家 (如: 科锐 CR、三星 SS、飞利浦 PH.....)
- H6:** 光源尺寸 (如:2835、3030、3535、.....)



特征&典型应用

- 3 种不同配光角度
- 效率高
- 均匀度优良
- 透镜无支架
- 工况灯

材质信息

透镜材料：PC 1225Z

工作温度范围：-40℃~+110℃（上限值+120℃）

存储温度范围：-40℃~+110℃（上限值+120℃）

*400nm~700nm 可见光平均透过率>90%

使用注意事项

1. 如有必要，用软性肥皂、水和软布清洗透镜。
2. 禁止用工业溶剂清洗透镜，例如酒精。
3. 拿透镜时请带手套，因为皮肤油会影响透镜光学特性。



HH-383-6-xx-PH3030

光学参数

v1.0_20210119

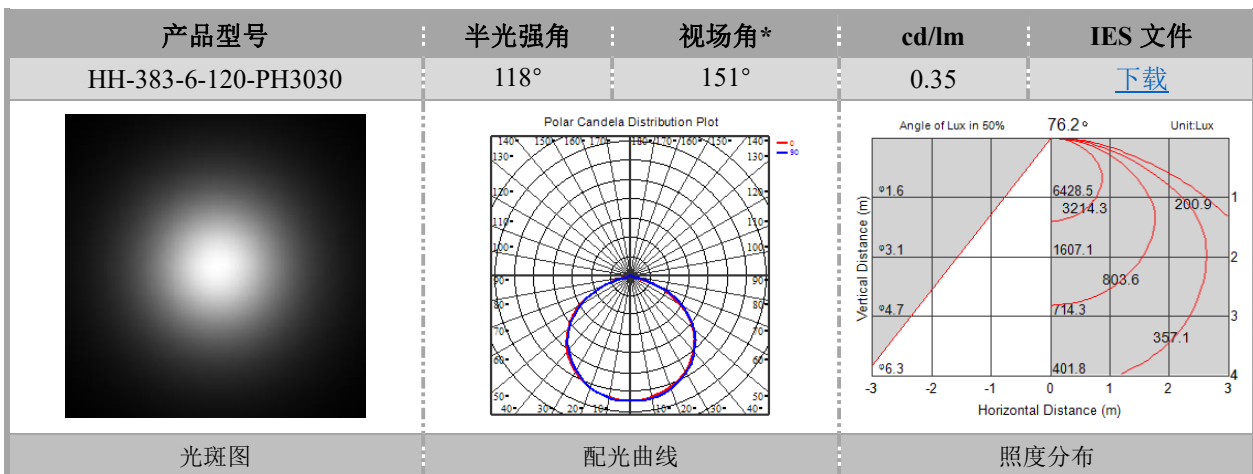
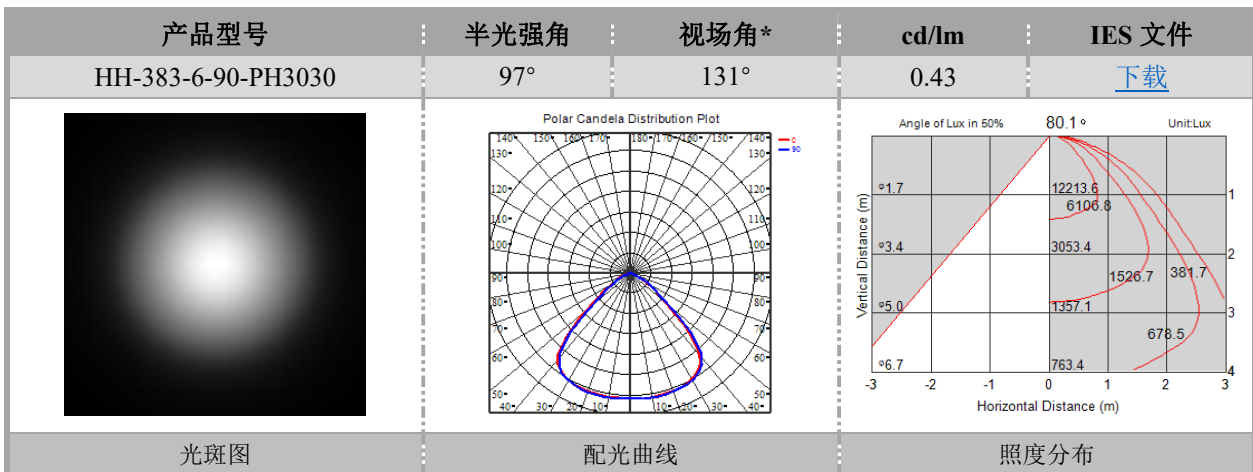
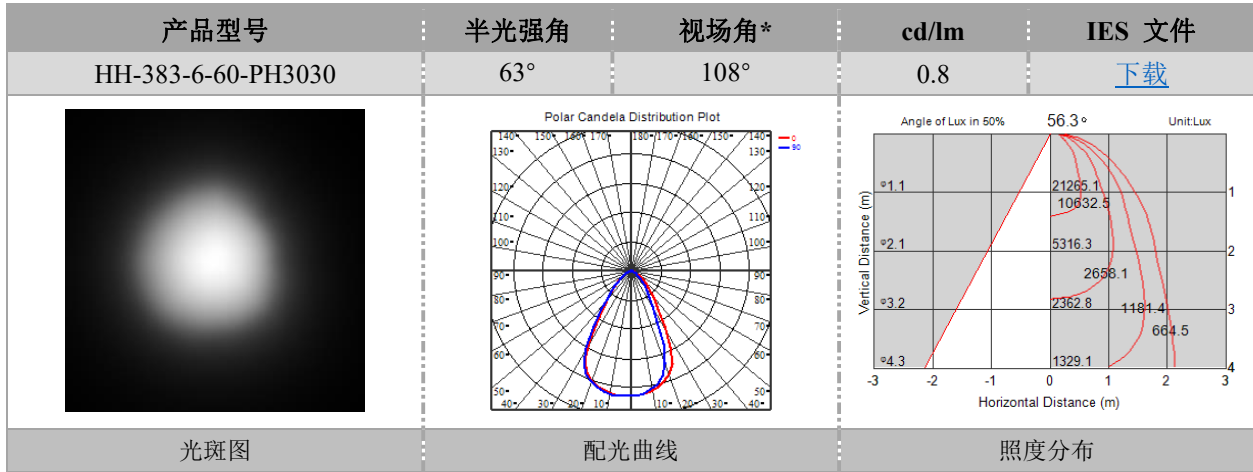

HH-383-6-xx-PH3030

结构参数

v1.0_20210119

注：(1) 所有计量单位均为 mm。
(2) 若无特殊说明，所有公差均为 ± 0.15

1. 安装固定方式

- 胶水
 螺丝
 胶带
 固定圈
 支架

2. 透镜尺寸

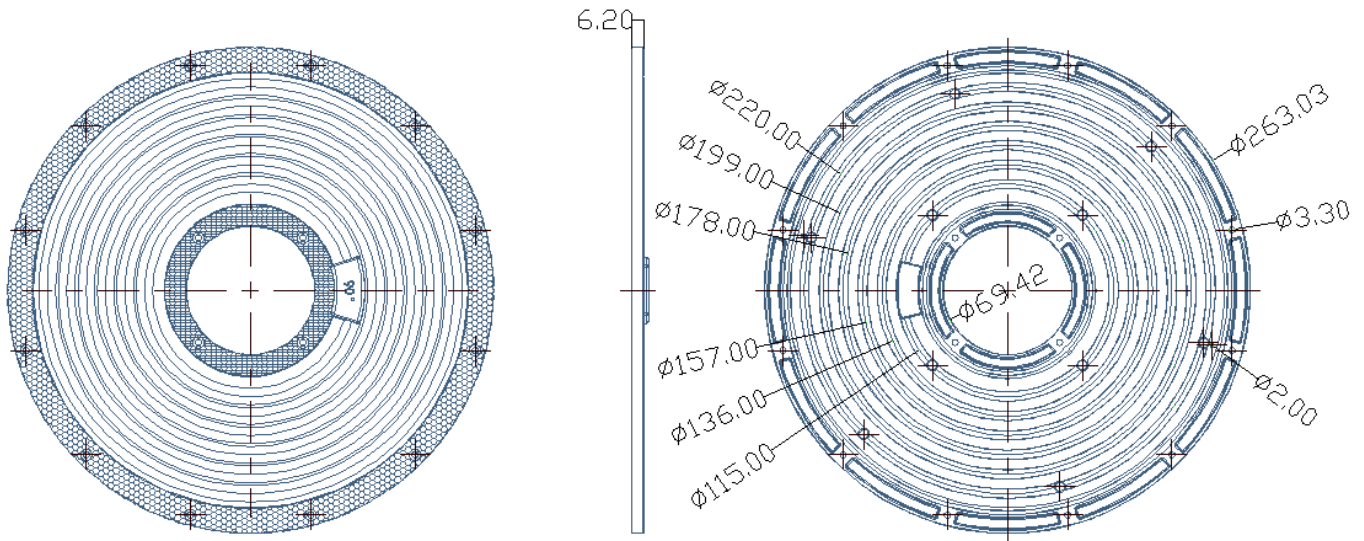

3. 装配指示

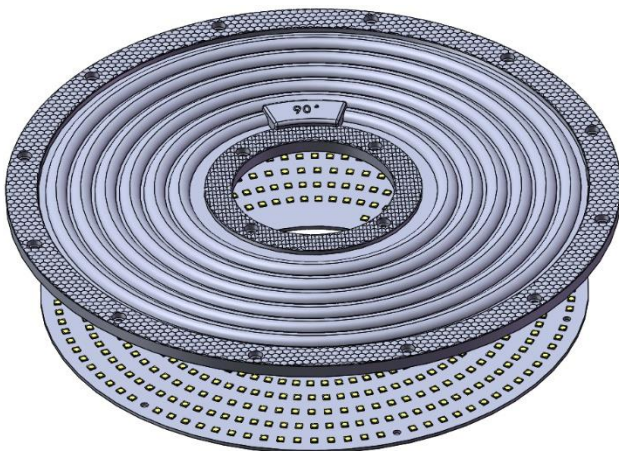

4. 透镜装配视图



HH-383-6-xx-PH3030

包装规格

v1.0_20210119

项目	数量	全部	尺寸(L*W*H)	毛重
内盒				
外箱				



Note:

