

# 产品数据表

HH-182-105×1-xx-OS3737

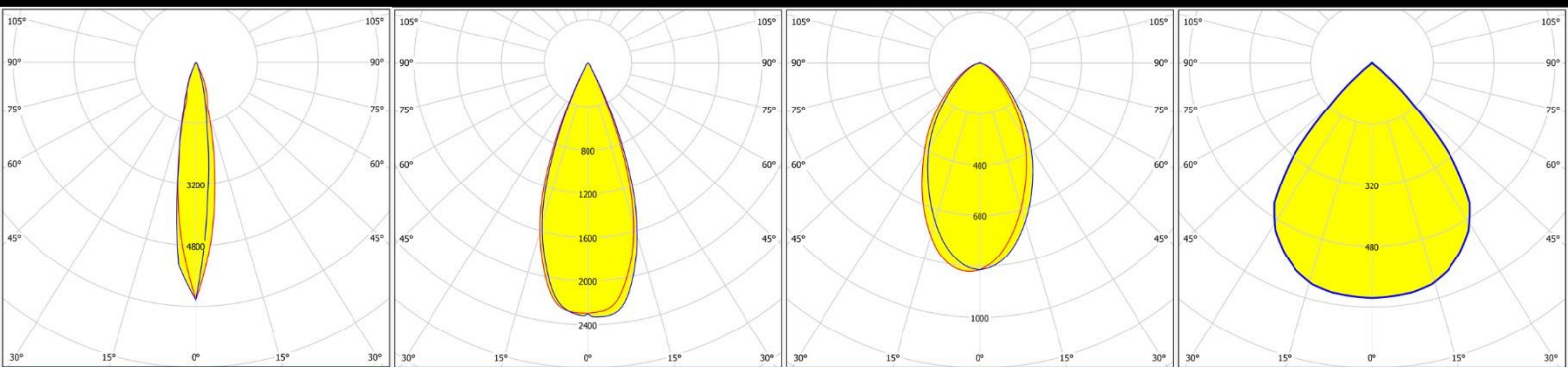
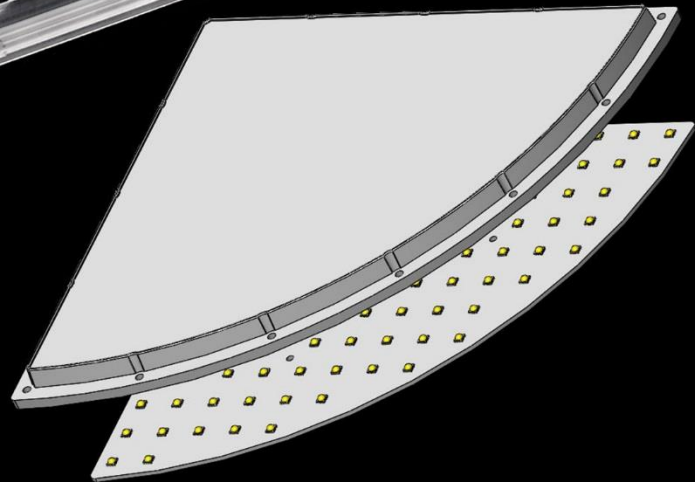

**深圳市汉辉光电有限公司**  
 shenzhen hanhui photoelectric co.,Ltd.

地址：深圳市宝安区石岩街道石龙仔社区恒昌荣高科技科技园3栋3楼  
 ADD: Area A No.3 Building 3th Floor,Hengchang Rong Industrial  
 park shiyan,shilong community,Bao'an District,shenzhen,china  
 TEL:86-755-29232420 FAX:86-755-83723765  
<http://www.szhanhui.com> <http://linsen4880.1688.com>



基本信息	.....	P.1
光学参数	.....	P.2
结构参数	.....	P.3
包装规格	.....	P.4

### \*产品编号说明

HH-182-105 × 1-xx-OS3737

H1                  H2                  H3                  H4    H5                  H6                  H7

H1: 公司拼音首字母 (Han Hui)

H2: 所属模具模号

H3: 光学面数量

H4: 单个光学面内灯珠数量

H5: 透镜角度/类型 (如: 60、90、T2M、T3M)

H6: 光源厂家 (如: 科锐CR、三星SS、欧司朗OS.....)

H7: 光源尺寸 (如:2835、3030、3535、.....)



## HH-182-105×1-xx-OS3737

## 基本信息

v1.0\_20181117

## ◆ 特征&amp;典型应用

- 3种不同配光角度
- 效率高
- 均匀度优良
- 透镜无支架
- 球场灯

## ◆ 材质信息

透镜材料：PC 1225Z

工作温度范围：-40℃~+110℃（上限值+120℃）

存储温度范围：-40℃~+110℃（上限值+120℃）

\*400nm~700nm可见光平均透过率>90%

## ◆ 使用注意事项

1. 如有必要，用软性肥皂、水和软布清洗透镜。
2. 禁止用工业溶剂清洗透镜，例如酒精。
3. 拿透镜时请带手套，因为皮肤油会影响透镜光学特性。



# HH-182-105×1-xx-OS3737

## 光学参数

v1.0\_20181117

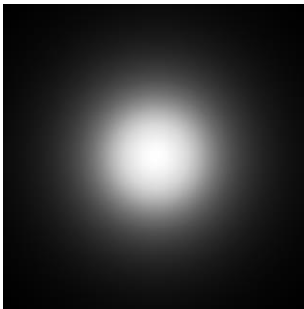
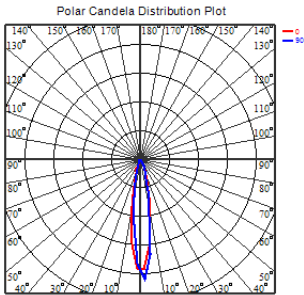
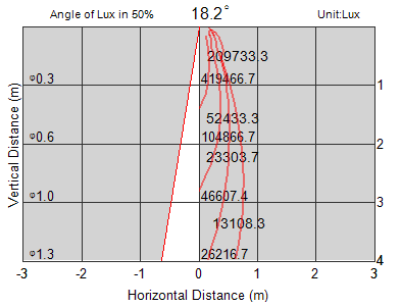
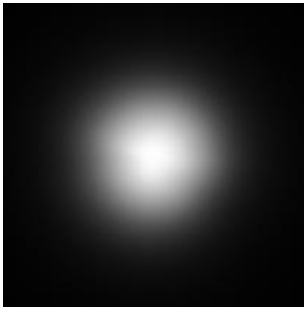
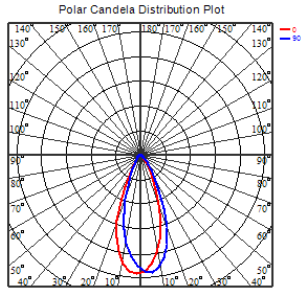
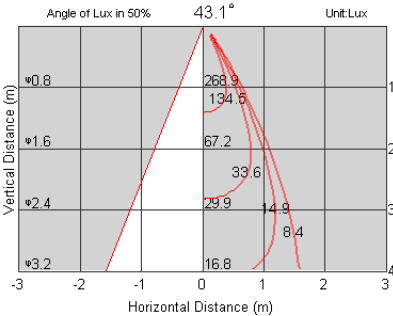
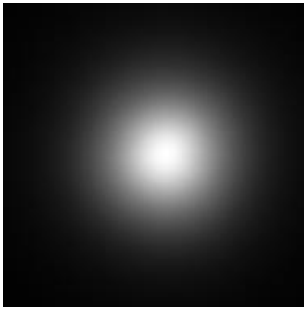
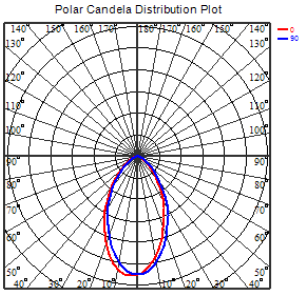
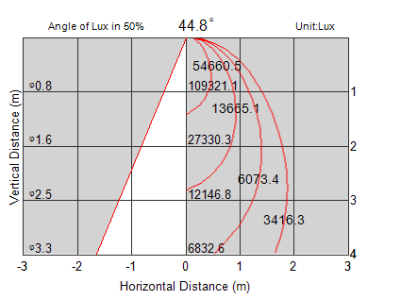
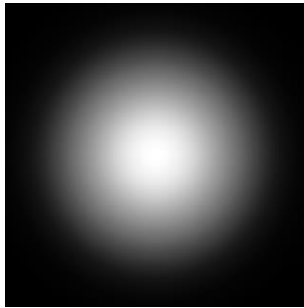
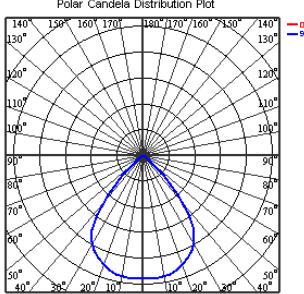
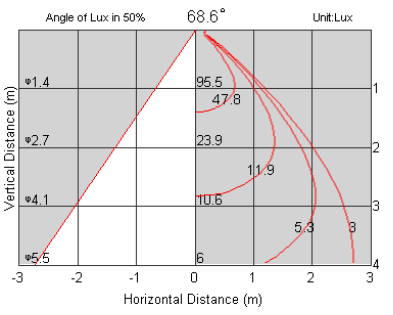
产品型号	半光强角	视场角*	cd/lm	IES 文件
HH-182-105×1-15-OS3737	15.7°	37.4°	6.5	<a href="#">下载</a>
				
HH-182-105×1-40-OS3737	40°	57.5°	1.6	<a href="#">下载</a>
				
HH-182-105×1-60-OS3737	59.1°	115.5°	0.8	<a href="#">下载</a>
				
HH-182-105×1-80-OS3737	80.3°	101.3°	0.69	<a href="#">下载</a>
				
光斑图	配光曲线	照度分布		



# HH-182-105×1-xx-OS3737

## 结构参数

v1.0\_20181117

注：(1) 所有计量单位均为 mm。  
(2) 若无特殊说明，所有公差均为 ±0.15

### 1. 安装固定方式

□ 胶水      ■ 螺丝      □ 胶带      □ 固定圈      □ 支架

### 2. 透镜尺寸

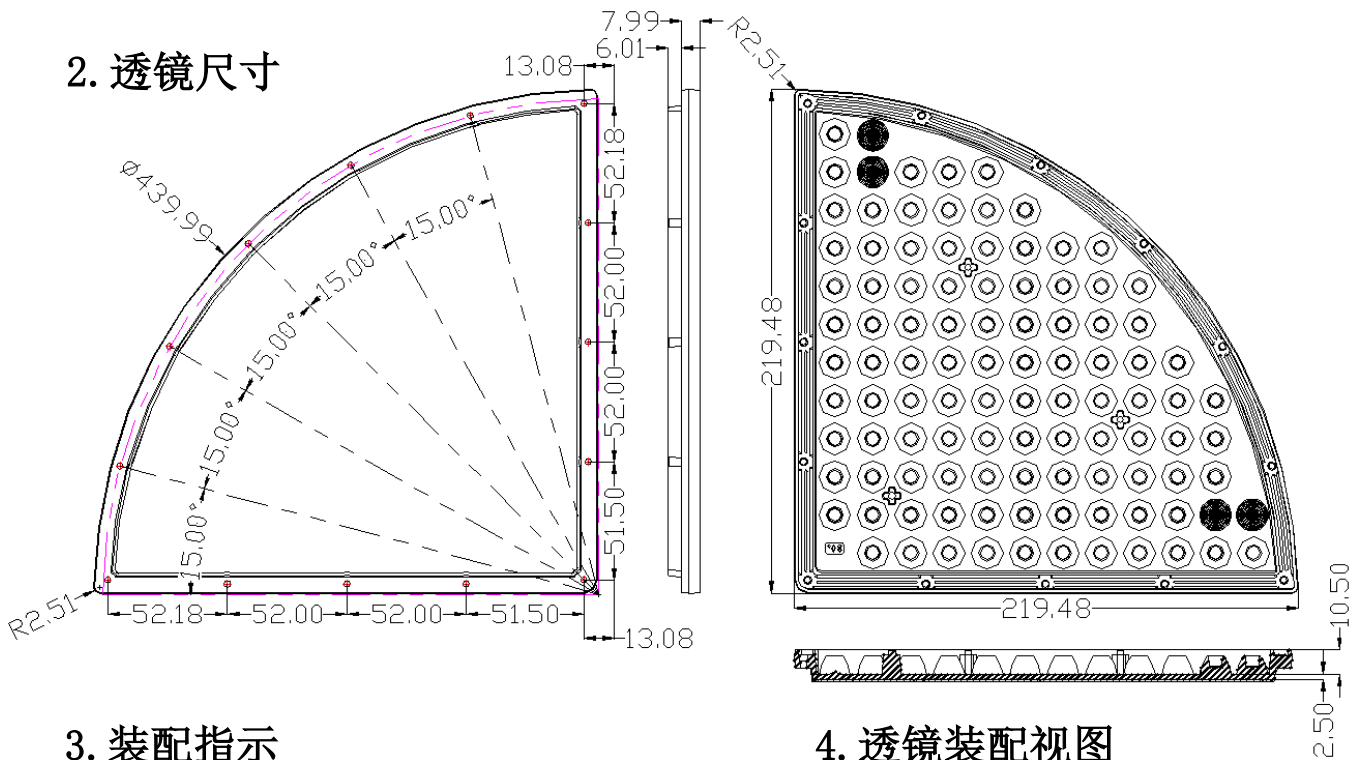

### 3. 装配指示

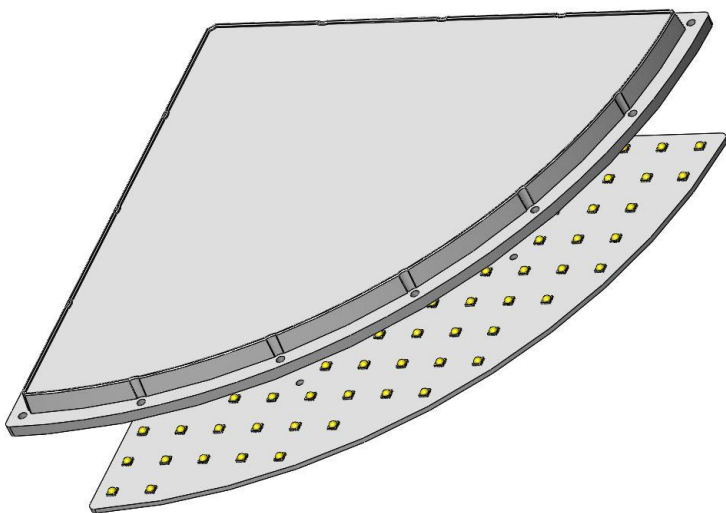

### 4. 透镜装配视图

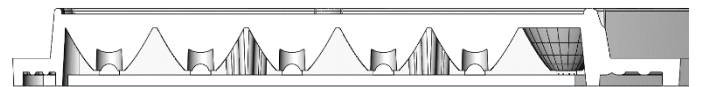

# HH-182-105×1-xx-OS3737

## 包装规格

v1.0\_20181117

项目	数量	全部	尺寸(L*W*H)	毛重
内盒	-	-	-	
外箱	1 箱	32PCS	38.5*28.5*23cm	

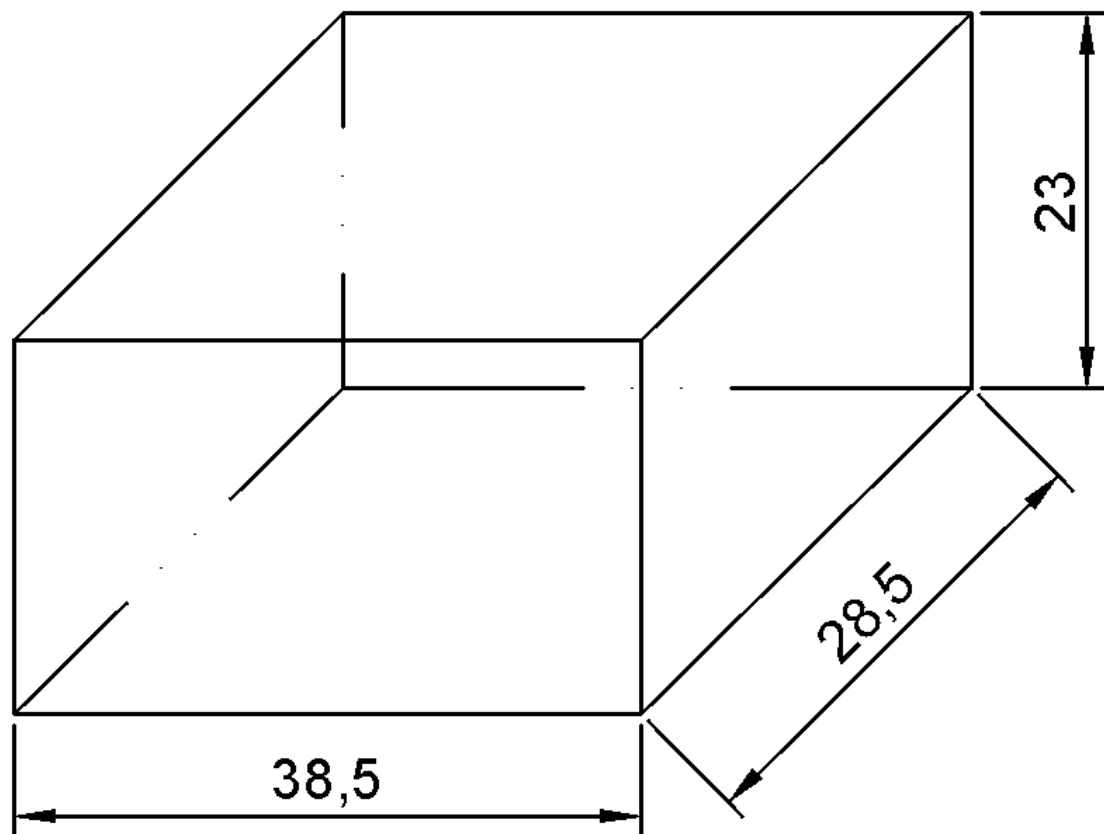

Note:

